

Description & Dimensions	Weight (kg)	Cat. No.
--------------------------	-------------	----------

Support Frame B1	60.0	6046035
------------------	------	---------

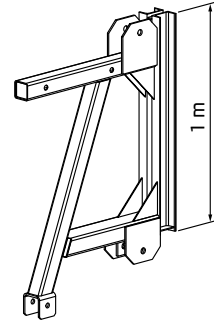

Support Frame B2	166.0	6046040
------------------	-------	---------

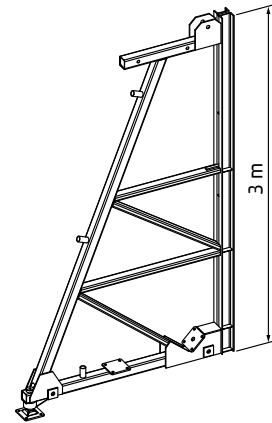

Support Frame B3	363.0	6046050
------------------	-------	---------

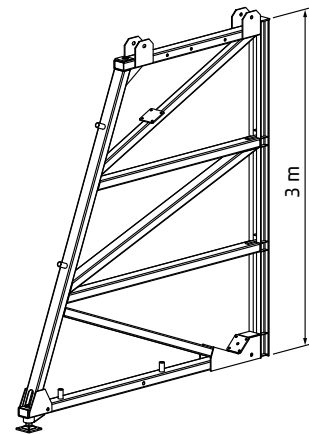



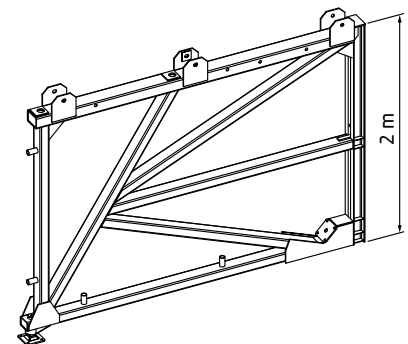

Support Frame B4	355.0	6046055
------------------	-------	---------

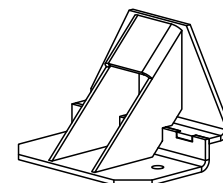

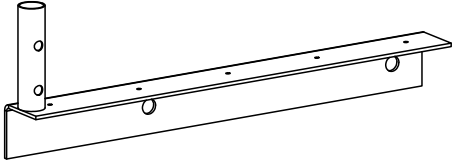
Support Frame Stopper	15.0	6046080
-----------------------	------	---------

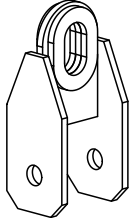
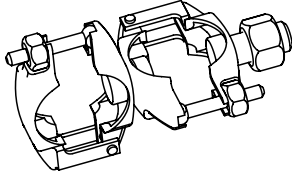
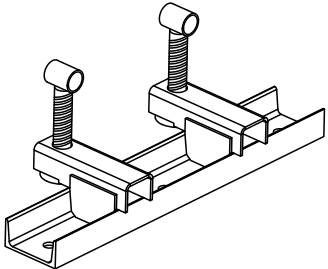
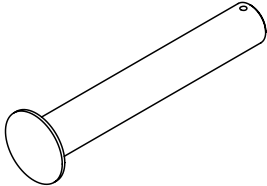

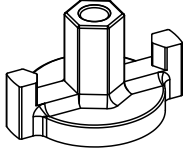
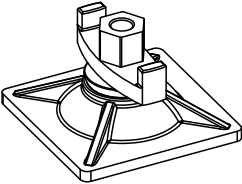
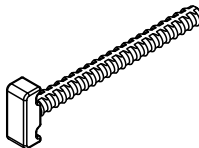
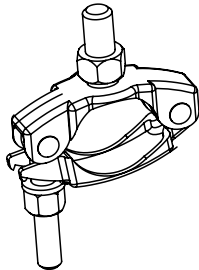
Description & Dimensions	Weight (kg)	Cat. No.	
Pouring Platform B	4.0	6046090	
Platform End Rail	2.4	96500440	
Lifting Element	5.0	6046060	
Double Swivel Coupler	1.3	96500210	
Fastening Element	14.5	6046030	
Pin Ø1"	1.0	91300130-1	

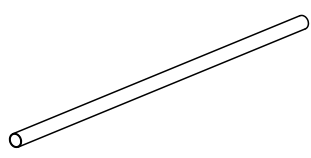
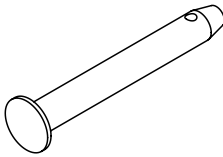
Description & Dimensions	Weight (kg)	Cat. No.	
Nut 705	0.4	96100010	
Nut 1205	1.1	96200040	
Fixing Bolt T25	0.5	5900190	
Fixing Bolt T35	0.8	5900191	
Swivel Coupler	0.6	96500211	
Tie Rod 15 mm L=0.50 m	0.7	96200180-1	
Scaffold Tube 1¼" L=1.00 m	2.5	5541000	
Scaffold Tube 1¼" L=1.50 m	3.8	5541500	
Scaffold Tube 1¼" L=2.00 m	5.0	5542000	
Scaffold Tube 1¼" L=2.50 m	6.3	5542500	
Scaffold Tube 1¼" L=3.00 m	7.5	5543000	
Scaffold Tube 1¼" L=3.50 m	8.8	5543500	
Scaffold Tube 1¼" L=4.00 m	10.0	5544000	
Pin Ø14 mm	0.15	91300050	
Pin R Galvanized 4x75	0.01	91300010	